

## Ex-Recess-mounted ceiling emergency light fittings in metal design

eLLB 20... V-CG-S / eLLB 20... NIB  
(Zone 1, 2, 21, 22)

### The explosion-protection lighting concept for clean rooms

The Ex recess-mounted ceiling emergency lighting eLLB 20 fittings are equipped with EVG 09 electronic ballasts and are suitable for two-pin fluorescent lamps. These light fittings are used for surface and flush mounting in ceilings, in particular in clean rooms where smooth, flush surfaces are very important. They are often used in the pharmaceutical and chemical industries, and experimental facilities, as well as in paint shops and spraying cabinets.

### Designed for easy installation

The housing is made of white-painted steel sheet with an integrally moulded cover frame or, optionally, of polished stainless steel. It is installed securely in the ceiling by means of special fixing elements that allow a universal and simple mounting in recessed clean room ceilings that are 25 to 90 mm thick. In addition, it can also be fixed by means of two M8 drilled holes in the top of the housing. The hinged, frameless pane made of safety glass

is fixed with captive screws and has inside hinges. The sealing material is guaranteed silicone-leak-proof. Together with the generously dimensioned terminal compartment, the standard, double-ended through-wiring allows a cost-saving installation.

### With central monitoring

Safety is always our top priority. This is why we also supply the eLLB 20 recessed ceiling mounting light fitting series with a built-in V-CG-S module. These luminaires with individual monitoring can be connected to a CEAG emergency lighting supply system and, in the event of an emergency, they provide a reliable illumination of your safety and escape routes.

### If you need a reliable and decentralised emergency lighting

Emergency lighting eLLB 20 NIB luminaires with a self-contained battery system provide a decentralised solution for the mandatory emergency lighting, independent of central systems. In large plants, in particular, these luminaires offer significant cost benefits.

### More safety due to sophisticated micro-electronics

Thanks to a new charging and monitoring technology with intelligent microelectronics, the NIB emergency lighting luminaires provide reliable safety and reduced maintenance costs. A function test lasting 5 minutes, that is carried out automatically on a weekly basis, even during mains operation, and a quarterly partial duty-cycle test provide additional safety.



### Features

- Standard dual channel ballast with EOL monitoring
- Flush installation, specially for clean rooms
- Available in painted sheet steel or stainless steel
- Safety interlocking due to integral automatic disconnecter
- Automatic function test and partial duty cycle test
- LED display for indication of charging, operation or fault status
- Easy replacement of battery, even in Ex-area
- High degree of protection IP66
- Connection to CEAG emergency light monitoring systems possible (V-CG-S)
- Suitable for ceiling B15 fire resistance



and drastically reduce the necessary amount of manual tests. The charging and discharging functions are monitored constantly by the micro-processor and are indicated via a diode display. Only the spent energy is recharged – therefore, overcharging is not possible. The so-called memory effect cannot occur – the service life of the battery is optimized.

The need to replace a battery, a fault in the emergency lighting circuit or a faulty battery is indicated by the LED display. Due to a new type of battery connection, the battery can be replaced in the hazardous area. The emergency lighting cycle can be set locally for 1.5 or 3 hours. A remote switch inquiry is possible in conjunction with the twin-ended through-wiring. The separate battery housing can be mounted directly onto the light fitting or it can be recess-mounted up to 1.5 m away, depending on the ceiling raster. Connection is made using eXLink connectors and no tools are required.





### Long-term safety

The recess-mounted ceiling luminaires of this robust lighting series with plastic enclosure are equipped with a highly-efficient electronic ballast, which has a reliable EOL circuit. Thus, the lamps are checked for proper operation and shut down safely in the event of a malfunction at the end of the service life. In addition, the dual-channel structure of the electronic ballasts allows the safe operation of the second lamp if one lamp fails.



Battery set NIB

## Ordering details





Type	Content	Terminals	Through-wiring single-ended	Through-wiring twin-ended	Cable gland/thread	Threaded plug	Blanking plug	Order No.
<b>eLLB 20018/18 V-CG-S</b>								
	eLLB 20018/18 V-CG-S (2 x 18 W) painted	2 x 6	–	x	2 x M25, plastic	2 x M25	1	<b>1 2190 218 703</b>
	eLLB 20018/18 V-CG-S (2 x 18 W) painted	2 x 6	–	x	4 x M20, metal thread	2 x M20		<b>1 2190 218 713</b>
	eLLB 20018/18 V-CG-S (2 x 18 W) st. steel	2 x 6	–	x	4 x M20, metal thread	2 x M20		<b>1 2190 218 723</b>
	eLLB 20018/18 V-CG-S (2 x 18 W) st. steel	2 x 6	–	x	2 x M25, plastic	2 x M25	1	<b>1 2190 218 733</b>
<b>eLLB 20036/36 V-CG-S</b>								
	eLLB 20036/36 V-CG-S (2 x 36 W) painted	2 x 6	–	x	2 x M25, plastic	2 x M25	1	<b>1 2190 236 703</b>
	eLLB 20036/36 V-CG-S (2 x 36 W) painted	2 x 6	–	x	4 x M20, metal thread	2 x M20		<b>1 2190 236 713</b>
	eLLB 20036/36 V-CG-S (2 x 36 W) st. steel	2 x 6	–	x	4 x M20, metal thread	2 x M20		<b>1 2190 236 723</b>
	eLLB 20036/36 V-CG-S (2 x 36 W) st. steel	2 x 6	–	x	2 x M25, plastic	2 x M25	1	<b>1 2190 236 733</b>
<b>eLLB 20058/58 V-CG-S</b>								
	eLLB 20058/58 V-CG-S (2 x 58 W) painted	2 x 6	–	x	2 x M25, plastic	2 x M25	1	<b>1 2190 258 703</b>
	eLLB 20058/58 V-CG-S (2 x 58 W) painted	2 x 6	–	x	4 x M20, metal thread	2 x M20		<b>1 2190 258 713</b>
	eLLB 20058/58 V-CG-S (2 x 58 W) st. steel	2 x 6	–	x	4 x M20, metal thread	2 x M20		<b>1 2190 258 723</b>
	eLLB 20058/58 V-CG-S (2 x 58 W) st. steel	2 x 6	–	x	2 x M25, plastic	2 x M25	1	<b>1 2190 258 733</b>
<b>eLLB 20418 V-CG-S</b>								
	eLLB 20418 V-CG-S (4 x 18 W) painted	2 x 6	–	x	2 x M25, plastic	2 x M25	1	<b>1 2190 418 703</b>
	eLLB 20418 V-CG-S (4 x 18 W) painted	2 x 6	–	x	4 x M20, metal thread	2 x M20		<b>1 2190 418 713</b>
	eLLB 20418 V-CG-S (4 x 18 W) st. steel	2 x 6	–	x	4 x M20, metal thread	2 x M20		<b>1 2190 418 723</b>
	eLLB 20418 V-CG-S (4 x 18 W) st. steel	2 x 6	–	x	2 x M25, plastic	2 x M25	1	<b>1 2190 418 733</b>
<b>eLLB 20436 V-CG-S</b>								
	eLLB 20436 V-CG-S (4 x 36 W) painted	2 x 6	–	x	2 x M25, plastic	2 x M25	1	<b>1 2190 436 703</b>
	eLLB 20436 V-CG-S (4 x 36 W) painted	2 x 6	–	x	4 x M20, metal thread	2 x M20		<b>1 2190 436 713</b>
	eLLB 20436 V-CG-S (4 x 36 W) st. steel	2 x 6	–	x	4 x M20, metal thread	2 x M20		<b>1 2190 436 723</b>
	eLLB 20436 V-CG-S (4 x 36 W) st. steel	2 x 6	–	x	2 x M25, plastic	2 x M25	1	<b>1 2190 436 733</b>

<sup>1)</sup> with metal thread, without cable gland

Scope of delivery without lamp and fixing accessories

Metal cable glands see catalogue part 2: 2.3.12 ff

## Ordering details

Type	Content	Terminals	Through-wiring single-ended	Through-wiring twin-ended	Cable gland/thread	Threaded plug	Blanking plug	Order No.	
<b>eLLB 20018/18 NIB</b>									
	eLLB 20018/18 NIB (2 x 18 W)	2/6-2K painted	2 x 6	–	x	2 x M25, plastic	2 x M25	1	<b>1 2190 218 002</b>
	eLLB 20018/18 NIB (2 x 18 W)	2/6-2K - st. steel	2 x 6	–	x	2 x M25, plastic	2 x M25	1	<b>1 2190 218 012</b>
	eLLB 20018/18 NIB (2 x 18 W)	2/6-2M <sup>1)</sup> painted	2 x 6	–	x	4 x M20, metal thread	2 x M20		<b>1 2190 218 102</b>
	eLLB 20018/18 NIB (2 x 18 W)	2/6-2M <sup>1)</sup> st. steel	2 x 6	–	x	4 x M20, metal thread	2 x M20		<b>1 2190 218 112</b>
<b>eLLB 20036/36 NIB</b>									
	eLLB 20036/36 NIB (2 x 36 W)	2/6-2K painted	2 x 6	–	x	2 x M25, plastic	2 x M25	1	<b>1 2190 236 002</b>
	eLLB 20036/36 NIB (2 x 36 W)	2/6-2K - st. steel	2 x 6	–	x	2 x M25, plastic	2 x M25	1	<b>1 2190 236 012</b>
	eLLB 20036/36 NIB (2 x 36 W)	2/6-2M <sup>1)</sup> painted	2 x 6	–	x	4 x M20, metal thread	2 x M20		<b>1 2190 236 102</b>
	eLLB 20036/36 NIB (2 x 36 W)	2/6-2M <sup>1)</sup> st. steel	2 x 6	–	x	4 x M20, metal thread	2 x M20		<b>1 2190 236 112</b>
<b>eLLB 20418 NIB</b>									
	eLLB 20418 NIB (4 x 18 W)	2/6-2K painted	2 x 6	–	x	2 x M25, plastic	2 x M25	1	<b>1 2190 418 002</b>
	eLLB 20418 NIB (4 x 18 W)	2/6-2K - st. steel	2 x 6	–	x	2 x M25, plastic	2 x M25	1	<b>1 2190 418 012</b>
	eLLB 20418 NIB (4 x 18 W)	2/6-2M <sup>1)</sup> painted	2 x 6	–	x	4 x M20, metal thread	2 x M20		<b>1 2190 418 102</b>
	eLLB 20418 NIB (4 x 18 W)	2/6-2M <sup>1)</sup> st. steel	2 x 6	–	x	4 x M20, metal thread	2 x M20		<b>1 2190 418 112</b>
<b>eLLB 20436 NIB</b>									
	eLLB 20436 NIB (4 x 36 W)	2/6-2K painted	2 x 6	–	x	2 x M25, plastic	2 x M25	1	<b>1 2190 436 002</b>
	eLLB 20436 NIB (4 x 36 W)	2/6-2K - st. steel	2 x 6	–	x	2 x M25, plastic	2 x M25	1	<b>1 2190 436 012</b>
	eLLB 20436 NIB (4 x 36 W)	2/6-2M <sup>1)</sup> painted	2 x 6	–	x	4 x M20, metal thread	2 x M20		<b>1 2190 436 102</b>
	eLLB 20436 NIB (4 x 36 W)	2/6-2M <sup>1)</sup> st. steel	2 x 6	–	x	4 x M20, metal thread	2 x M20		<b>1 2190 436 112</b>

<sup>1)</sup> with metal thread, without cable gland

Scope of delivery without lamp and fixing accessories  
Metal cable glands see catalogue part 2: 2.3.12 ff

# 2.7

## Dimension drawing / Polar curve

eLLB 20 ... V-CG-S / eLLB 20 ... NIB

### Polar curve eLLB 20018/18 NIB / V-CG-S eLLB 20036/36 NIB / V-CG-S

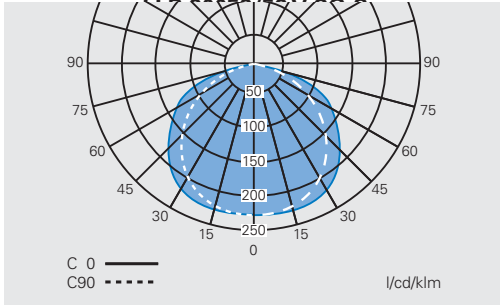

### Polar curve eLLB 20418 V-CG-S / NIB eLLB 20436 V-CG-S / NIB

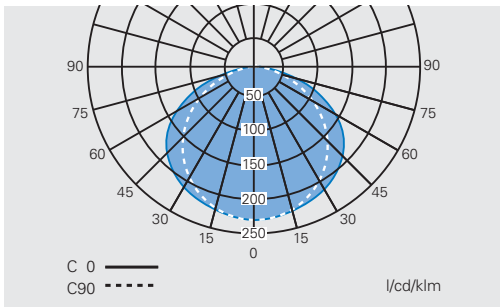

### eLLB 20...

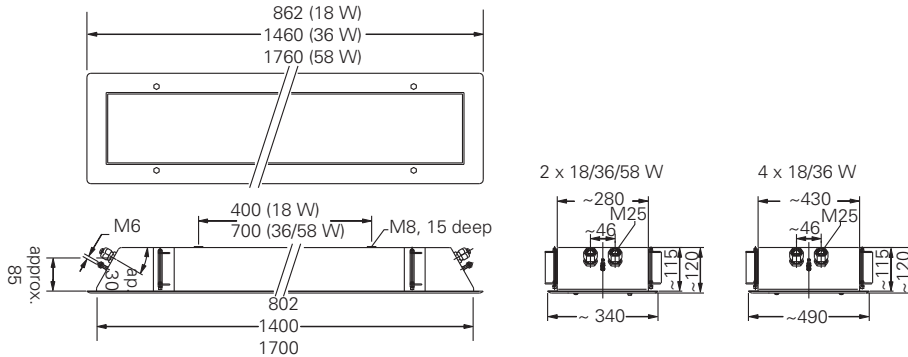

### eLLB 20...

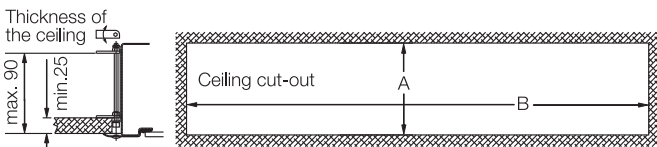

	A	B
eLLB 20018/18 V-CG-S/ NIB	315+3	832+5
eLLB 20036/36 V-CG-S/ NIB	315+3	1432+5
eLLB 20058/58 CG	315+3	1732+5
eLLB 20418 V-CG-S/NIB	465+3	832+5
eLLB 20436 V-CG-S/NIB	465+3	1432+5

### Battery housing

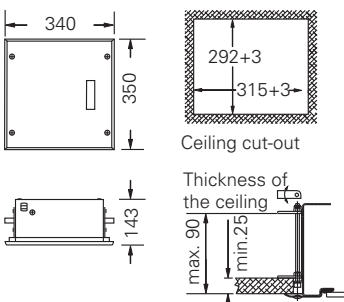

Dimensions in mm



## Technical data

### eLLB 20018/18 V-CG-S

EC-Type Examination Certificate	DMT 02 ATEX E 069
IECEX Certificate of Conformity	IECEX BK1 08.0017
Marking accd. to 94/9/EC	⊕ II 2 G Ex e d m IIC T4 ⊕ II 2 D tD A21 IP66 T80 °C
Marking accd. to IECEx	Ex edmb ib IIC T4 Gb Ex tb IIC IP66 T 80 °C Db
Permissible ambient temperature	-25 °C up to +50 °C
Rated voltage	220 - 254 V AC 195 - 250 V DC
Rated current	0.19 A
Frequency	50 - 60 Hz
Power factor cos φ	≥ 0.95
Circuit	EVG/CG-S
Protection class	I
Lamp / Illuminant	2 x T26 / 18 W (T8)
Rated luminous flux	2700 lm <sup>1)</sup>
Lamp cap	G13 accd. to IEC 60061-1
Light output ratio	70%
Luminous flux in emergency operation	1350 lm <sup>1)</sup>
Dimensions (L x W x H)	862 x 280 x 120 mm
Connecting terminals	L1, L2, L3, L, N, PE; max. 2 x 6 mm <sup>2</sup> per terminal, through-wiring twin-ended
Enclosure colour	white RAL 9010
Enclosure material	painted steel sheet, white optional polished stainless steel
Weight	15.5 kg
Cable glands / gland plates / enclosure drilling	Ex-e cable glands M25 x 1.5 (plastic), option: M20 x 1.5 metal thread <sup>2)</sup>
Degree of protection accd. to EN 60529	IP66
Protective cover / protective bowl	single-safety glass pane of 6 mm thick
Permissible ceiling tickness for fixing accessories	min. 25 mm to max. 90 mm

<sup>1)</sup> depends on used lamps

<sup>2)</sup> with dustcover if entry/thread is not closed



## Technical data

	eLLB 20036/36 V-CG-S	eLLB 20058/58 V-CG-S
EC-Type Examination Certificate	DMT 02 ATEX E 069	DMT 02 ATEX E 069
IECEX Certificate of Conformity	IECEX BK1 08.0017	IECEX BK1 08.0017
Marking accd. to 94/9/EC	⊕ II 2 G Ex e d m IIC T4 ⊕ II 2 D tD A21 IP66 T80 °C	⊕ II 2 G Ex e d m IIC T4 ⊕ II 2 D tD A21 IP66 T80 °C
Marking accd. to IECEx	Ex edmb ib IIC T4 Gb Ex tb IIIC IP66 T 80 °C Db	Ex edmb ib IIC T4 Gb Ex tb IIIC IP66 T 80 °C Db
Permissible ambient temperature	-25 °C up to +50 °C	-25 °C up to +50 °C
Rated voltage	220 - 254 V AC 195 - 250 V DC	220 - 254 V AC 195 - 250 V DC
Rated current	0.35 A	0.54 A
Frequency	50 - 60 Hz	50 - 60 Hz
Power factor cos φ	≥ 0.95	≥ 0.95
Circuit	EVG/CG-S	EVG/CG-S
Protection class	I	I
Lamp / Illuminant	2 x T26 / 36 W (T8)	2 x T26 / 58 W (T8)
Rated luminous flux	6700 lm <sup>1)</sup>	10400 lm <sup>1)</sup>
Lamp cap	G13 accd. to IEC 60061-1	G13 accd. to IEC 60061-1
Light output ratio	70%	68%
Luminous flux in emergency operation	3350 lm <sup>1)</sup>	5200 lm <sup>1)</sup>
Dimensions (L x W x H)	1460 x 280 x 120 mm	1760 x 280 x 120 mm
Connecting terminals	L1, L2, L3, L, N, PE; max. 2 x 6 mm <sup>2</sup> per terminal, through-wiring twin-ended	L1, L2, L3, L, N, PE; max. 2 x 6 mm <sup>2</sup> per terminal, through-wiring twin-ended
Enclosure colour	white RAL 9010	white RAL 9010
Enclosure material	painted steel sheet, white optional polished stainless steel	painted steel sheet, white optional polished stainless steel
Weight	22.5 kg	26.5 kg
Cable glands / gland plates / enclosure drilling	Ex-e cable glands M25 x 1.5 (plastic), option: M20 x 1.5 metal thread <sup>2)</sup>	Ex-e cable glands M25 x 1.5 (plastic), option: M20 x 1.5 metal thread <sup>2)</sup>
Degree of protection accd. to EN 60529	IP66	IP66
Protective cover / protective bowl	single-safety glass pane of 6 mm thick	single-safety glass pane of 6 mm thick
Permissible ceiling tickness for fixing accessories	min. 25 mm to max. 90 mm	min. 25 mm to max. 90 mm

<sup>1)</sup> depends on used lamps<sup>2)</sup> with dustcover if entry/thread is not closed



## Technical data

	eLLB 20418 V-CG-S	eLLB 20436 V-CG-S
EC-Type Examination Certificate	DMT 02 ATEX E 069	DMT 02 ATEX E 069
IECEX Certificate of Conformity	IECEX BK1 08.0017	IECEX BK1 08.0017
Marking accd. to 94/9/EC	⊕ II 2 G Ex e d m IIC T4 ⊕ II 2 D tD A21 IP66 T80 °C	⊕ II 2 G Ex e d m IIC T4 ⊕ II 2 D tD A21 IP66 T80 °C
Marking accd. to IECEx	Ex edmb ib IIC T4 Gb Ex tb IIIC IP66 T 80 °C Db	Ex edmb ib IIC T4 Gb Ex tb IIIC IP66 T 80 °C Db
Permissible ambient temperature	-25 °C up to +50 °C	-25 °C up to +50 °C
Rated voltage	220 - 254 V AC 195 - 250 V DC	220 - 254 V AC 195 - 250 V DC
Rated current	0.37 A	0.69 A
Frequency	50 - 60 Hz	50 - 60 Hz
Power factor cos φ	≥ 0.95	≥ 0.95
Circuit	EVG/CG-S	EVG/CG-S
Protection class	I	I
Lamp / Illuminant	4 x T26 / 18 W (T8)	4 x T26 / 36 W (T8)
Rated luminous flux	5400 lm <sup>1)</sup>	13400 lm <sup>1)</sup>
Lamp cap	G13 accd. to IEC 60061-1	G13 accd. to IEC 60061-1
Light output ratio	69%	69%
Luminous flux in emergency operation	1350 lm <sup>1)</sup>	3350 lm <sup>1)</sup>
Dimensions (L x W x H)	862 x 430 x 120 mm	1460 x 430 x 120 mm
Connecting terminals	L1, L2, L3, L, N, PE; max. 2 x 6 mm <sup>2</sup> per terminal, through-wiring twin-ended	L1, L2, L3, L, N, PE; max. 2 x 6 mm <sup>2</sup> per terminal, through-wiring twin-ended
Enclosure colour	white RAL 9010	white RAL 9010
Enclosure material	painted steel sheet, white optional polished stainless steel	painted steel sheet, white optional polished stainless steel
Weight	25.5 kg	34.5 kg
Cable glands / gland plates / enclosure drilling	Ex-e cable glands M25 x 1.5 (plastic), option: M20 x 1.5 metal thread <sup>2)</sup>	Ex-e cable glands M25 x 1.5 (plastic), option: M20 x 1.5 metal thread <sup>2)</sup>
Degree of protection accd. to EN 60529	IP66	IP66
Protective cover / protective bowl	single-safety glass pane of 6 mm thick	single-safety glass pane of 6 mm thick
Permissible ceiling tickness for fixing accessories	min. 25 mm to max. 90 mm	min. 25 mm to max. 90 mm

<sup>1)</sup> depends on used lamps

<sup>2)</sup> with dustcover if entry/thread is not closed



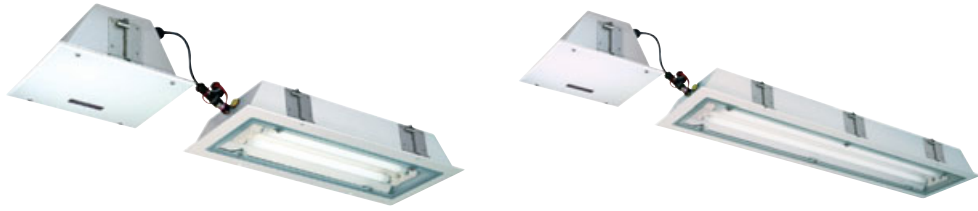

## Technical data

	eLLB 20018/18 NIB	eLLB 20036/36 NIB
EC-Type Examination Certificate	DMT 02 ATEX E 069	DMT 02 ATEX E 069
IECEX Certificate of Conformity	IECEX BK1 08.0017	IECEX BK1 08.0017
Marking accd. to 94/9/EC	<ul style="list-style-type: none"> <li>⊕ II 2 G Ex e d m ib IIC T4</li> <li>⊕ II 2 D tD A21 IP66 T80 °C</li> </ul>	<ul style="list-style-type: none"> <li>⊕ II 2 G Ex e d m ib IIC T4</li> <li>⊕ II 2 D tD A21 IP66 T80 °C</li> </ul>
Marking accd. to IECEx	Ex edmb ib IIC T4 Gb Ex tb IIIC IP66 T 80 °C Db	Ex edmb ib IIC T4 Gb Ex tb IIIC IP66 T 80 °C Db
Permissible ambient temperature	-20 °C up to +50 °C (specified data: -5 °C up to +35 °C)	-20 °C up to +50 °C (specified data: -5 °C up to +35 °C)
Battery	battery set with 7 Ah-NC battery, with LED display and monitoring via microprocessor	battery set with 7 Ah-NC battery, with LED display and monitoring via microprocessor
Rated voltage	220 - 254 V AC	220 - 254 V AC
Rated voltage (optional)	110 - 127 V AC	110 - 127 V AC
Rated current	0.23 A	0.40 A
Frequency	50 - 60 Hz	50 - 60 Hz
Charging duration	≥ 14 h	≥ 14 h
Power factor cos φ	≥ 0.95	≥ 0.95
Circuit	EVG with emergency lighting supply	EVG with emergency lighting supply
Protection class	I	I
Lamp / Illuminant	2 x T26 / 18 W (T8)	2 x T26 / 36 W (T8)
Rated luminous flux	2600 lm <sup>1)</sup>	6700 lm <sup>1)</sup>
Lamp cap	G13 accd. to IEC 60061-1	G13 accd. to IEC 60061-1
Light output ratio	70%	70%
Luminous flux in emergency operation (1.5 h, one lamp)	1215 lm (90 %)	1507 lm (45 %)
Luminous flux in emergency operation (3 h, one lamp)	607 lm (45 %)	837 lm (25 %)
Rated emergency lighting duration	1-lamps can be set on site for an emergency lighting duration of 1.5 or 3 hours	1-lamps can be set on site for an emergency lighting duration of 1.5 or 3 hours
Dimensions (L x W x H)	862 x 280 x 120 mm	1460 x 280 x 120 mm
Battery housing dimensions (L x W x H)	305 x 340 x 143 mm	305 x 340 x 143 mm
Connection battery enclosure	connection via 1.5 m long connection lead with plugs	connection via 1.5 m long connection lead with plugs
Connecting terminals	L1, L2, L3, L, N, PE; max. 2 x 6 mm <sup>2</sup> per terminal	L1, L2, L3, L, N, PE; max. 2 x 6 mm <sup>2</sup> per terminal
Enclosure colour	white RAL 9010	white RAL 9010
Enclosure material	painted steel sheet, white optional polished stainless steel	painted steel sheet, white optional polished stainless steel
Weight	18 kg	25 kg
Battery housing weight	5.7 kg	5.7 kg
Cable glands / gland plates / enclosure drilling	Ex-e cable glands M25 x 1.5 (plastic), option: M20 x 1.5 metal thread <sup>2)</sup>	Ex-e cable glands M25 x 1.5 (plastic), option: M20 x 1.5 metal thread <sup>2)</sup>
Degree of protection accd. to EN 60529	IP66	IP66
Protective cover / protective bowl	single-safety glass pane of 6 mm thick	single-safety glass pane of 6 mm thick
Permissible ceiling tickness for fixing accessories	min. 25 mm to max. 90 mm	min. 25 mm to max. 90 mm

<sup>1)</sup> depends on used lamps<sup>2)</sup> with dustcover if entry/thread is not closed



Technical data

	eLLB 20418 NIB	eLLB 20436 NIB
EC-Type Examination Certificate	DMT 02 ATEX E 069	DMT 02 ATEX E 069
IECEX Certificate of Conformity	IECEX BK1 08.0017	IECEX BK1 08.0017
Marking accd. to 94/9/EC	⊕ II 2 G Ex e d m ib IIC T4 ⊕ II 2 D tD A21 IP66 T80 °C	⊕ II 2 G Ex e d m ib IIC T4 ⊕ II 2 D tD A21 IP66 T80 °C
Marking accd. to IECEx	Ex edmb ib IIC T4 Gb Ex tb IIIC IP66 T 80 °C Db	Ex edmb ib IIC T4 Gb Ex tb IIIC IP66 T 80 °C Db
Permissible ambient temperature	-20 °C up to +50 °C (specified data: -5 °C up to +35 °C)	-20 °C up to +50 °C (specified data: -5 °C up to +35 °C)
Battery	battery set with 7 Ah-NC battery, with LED display and monitoring via microprocessor	battery set with 7 Ah-NC battery, with LED display and monitoring via microprocessor
Rated voltage	220 - 254 V AC	220 - 254 V AC
Rated voltage (optional)	110 - 127 V AC	110 - 127 V AC
Rated current	0.41 A	0.74 A
Frequency	50 - 60 Hz	50 - 60 Hz
Charging duration	≥ 14 h	≥ 14 h
Power factor cos φ	≥ 0.95	≥ 0.95
Circuit	EVG with emergency lighting supply	EVG with emergency lighting supply
Protection class	I	I
Lamp / Illuminant	4 x T26 / 18 W (T8)	4 x T26 / 36 W (T8)
Rated luminous flux	5400 lm <sup>1)</sup>	13400 lm <sup>1)</sup>
Lamp cap	G13 accd. to IEC 60061-1	G13 accd. to IEC 60061-1
Light output ratio	69%	69%
Luminous flux in emergency operation (1.5 h, one lamp)	1215 lm (90 %)	1507 lm (45 %)
Luminous flux in emergency operation (3 h, one lamp)	607 lm (45 %)	837 lm (25 %)
Rated emergency lighting duration	1-lamps can be set on site for an emergency lighting duration of 1.5 or 3 hours	1-lamps can be set on site for an emergency lighting duration of 1.5 or 3 hours
Dimensions (L x W x H)	862 x 430 x 120 mm	1460 x 430 x 120 mm
Battery housing dimensions (L x W x H)	305 x 340 x 143 mm	305 x 340 x 143 mm
Connection battery enclosure	connection via 1.5 m long connection lead with plugs	connection via 1.5 m long connection lead with plugs
Connecting terminals	L1, L2, L3, L, N, PE; max. 2 x 6 mm <sup>2</sup> per terminal	L1, L2, L3, L, N, PE; max. 2 x 6 mm <sup>2</sup> per terminal
Enclosure colour	white RAL 9010	white RAL 9010
Enclosure material	painted steel sheet, white optional polished stainless steel	painted steel sheet, white optional polished stainless steel
Weight	29 kg	38 kg
Battery housing weight	5.7 kg	5.7 kg
Cable glands / gland plates / enclosure drilling	Ex-e cable glands M25 x 1.5 (plastic), option: M20 x 1.5 metal thread <sup>2)</sup>	Ex-e cable glands M25 x 1.5 (plastic), option: M20 x 1.5 metal thread <sup>2)</sup>
Degree of protection accd. to EN 60529	IP66	IP66
Protective cover / protective bowl	single-safety glass pane of 6 mm thick	single-safety glass pane of 6 mm thick
Permissible ceiling tickness for fixing accessories	min. 25 mm to max. 90 mm	min. 25 mm to max. 90 mm

<sup>1)</sup> depends on used lamps

<sup>2)</sup> with dustcover if entry/thread is not closed